

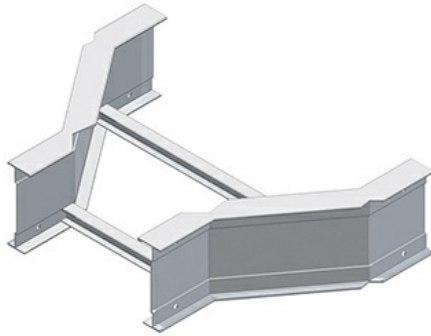

Cablofil
Horizontal Reducer Covers
Part No. P315218



The aluminum I-beam design of ITray is perfect for industrial installations with large diameter cables in long span situations, minimizing total tray width and creating a smooth transition between straight sections and fittings. A structural offset in the sidewall creates strong, mid-span splices that need fewer supports. Each splice snaps in place and stays without holding. Additionally, only four bolts are needed for each splice reducing hardware needs by 50%. These features allow Itray to be installed up to 30% faster than standard tray.

Features & Benefits

Material: Aluminum Alloy 5052 - H32

Finish: Plain

Width (W): Tray width: 6", 9", 12", 18", 24", 30", 36"

Specifications

General Info

Product Line	Cablofil	Finish	AL
UPC Number	800388211032	Country Of Origin	Mexico

Dimensions

Product Width US	13.802 in	Product Weight US	0.786 lb
Product Volume US	0.072 cu ft	Product Depth US	18.0 in
Product Height US	0.5 in		

Buy American Act Compliance

BAA	Yes
-----	-----